

SENNEBOGEN 643R

UDŹWIG MAKSYMALNY 40 TON

 **HERKULES**

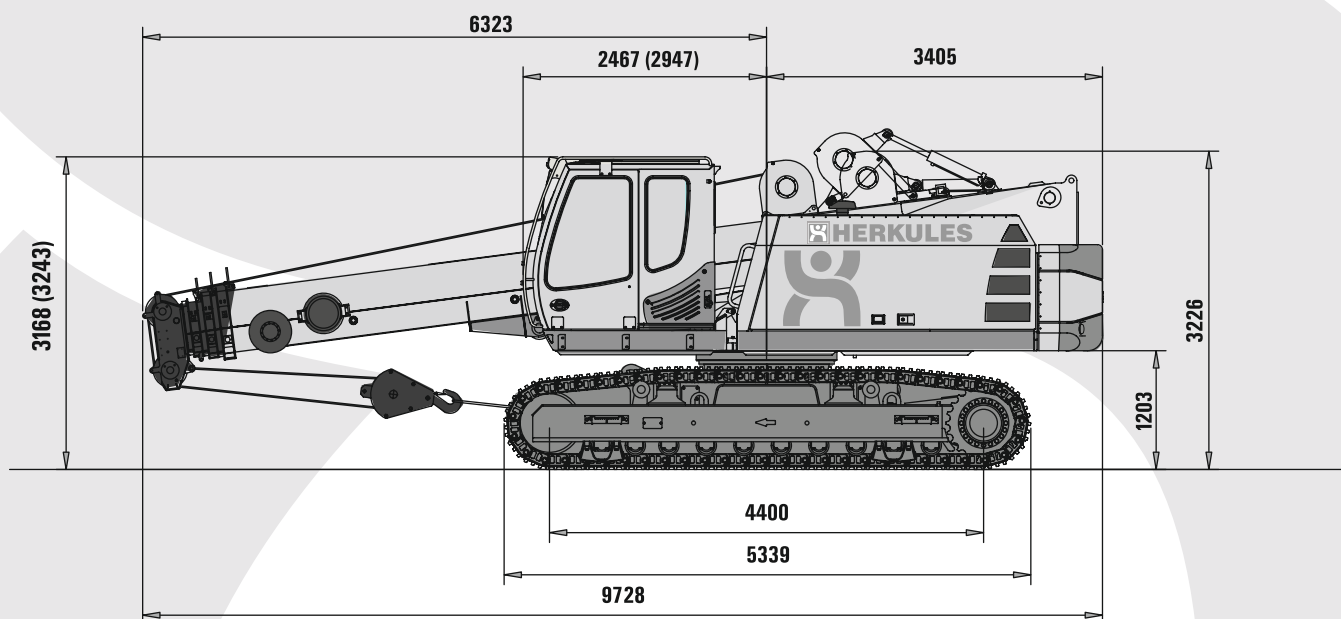
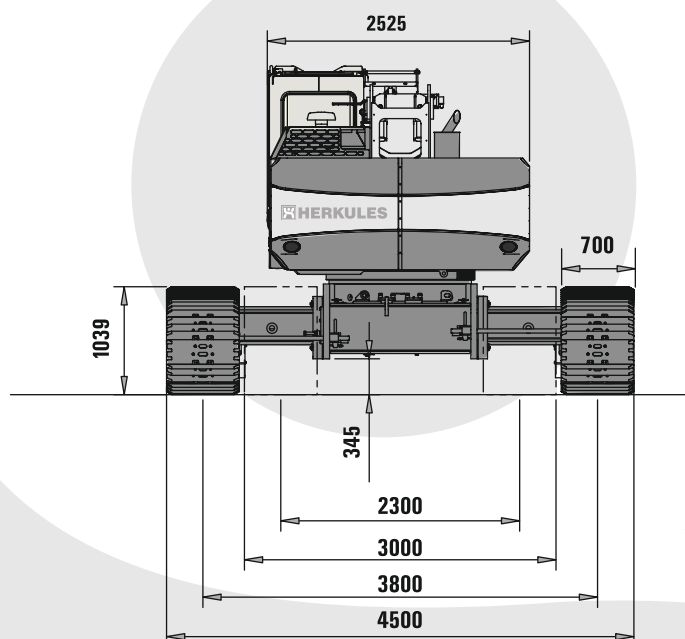

DANE TECHNICZNE:

UDŹWIG MAKSYMALNY: 40 TON
MAKSYMALNA PRZECIWWAGA: 7 + 4 TONY
OBSZAR PRACY : 360°

DŁUGOŚĆ WYSIĘGNIKA :
• PODSTAWOWEGO: 30 M
• POMOCNICZEGO : 13 M

SENNEBOGEN 643R

UDŹWIG MAKSYMALNY 40 TON

 **HERKULES**



9,0 m - 30,0 m

















360°



7t + 4t

Tabela udźwignięw żurawia Sennebogen 643 R - wysięgnik podstawowy, 7t + 4 tony przeciwwagi

m	9,0		12,5		16,0		19,5		23,0		26,5		30,0	
														
2,0	40,0*	40,0*												
3,0	35,0	33,0												
4,0	30,2	20,2	20,0	20,0	15,0	15,0	14,0	14,0	11,0	11,0	8,9	8,9	5,0	5,0
5,0	25,5	14,2	20,0	14,0	15,0	13,9	13,3	13,3	11,0	11,0	8,6	8,6	5,0	5,0
6,0	18,6	10,7	18,5	10,5	14,9	10,5	12,0	10,9	10,3	10,3	8,3	8,3	5,0	5,0
7,0	12,2/6,2m	10,2/6,2m	14,3	8,3	13,2	8,2	10,9	8,6	9,5	8,9	7,8	7,8	5,0	5,0
8,0			11,5	6,7	11,4	6,6	9,8	7,0	8,7	7,3	7,4	7,4	5,0	5,0
9,0			9,5	5,5	9,4	5,4	9,0	5,8	7,9	6,1	6,9	6,2	5,0	5,0
10,0			7,5/9,6m	4,9/9,6m	8,0	4,5	8,3	4,9	7,1	5,1	6,4	5,3	5,0	5,0
11,0					6,8	3,7	7,2	4,1	6,5	4,4	5,9	4,5	5,0	4,7
12,0					5,9	3,1	6,2	3,5	5,9	3,7	5,5	3,9	5,0	4,1
13,0					5,0	2,6	5,4	3,0	5,5	3,2	5,1	3,4	4,7	3,5
14,0							4,8	2,6	5,0	2,8	4,8	3,0	4,4	3,1
15,0							4,2	2,2	4,5	2,4	4,5	2,6	4,1	2,7
16,0							3,7	1,9	4,0	2,1	4,2	2,3	3,8	2,4
17,0							3,5/16,6m	1,7/16,6m	3,6	1,8	3,7	2,0	3,6	2,1
18,0									3,2	1,6	3,4	1,7	3,3	1,9
19,0									2,9	1,3	3,0	1,5	3,1	1,6
20,0									2,6	1,1	2,7	1,3	2,9	1,4
21,0									2,5/20,1m	1,1/20,1m	2,5	1,1	2,6	1,3
22,0											2,2	1,0	2,4	1,1
23,0											1,9/23,6m	0,7/23,6m	2,2	0,9
24,0													2,0	0,8
25,0													1,8	0,7
26,0													1,6	0,6
27,0	Spur 3800	Tab.Nr.: 643R-30.0/75/1977/7.0/08.06											1,5	0,5
28,0	Spur 2300	Tab.Nr.: 643R-30.0/75/1227/7.0/08.06											1,5/27,1m	0,5/27,1m
Parts reeving	10	10	6	6	5	5	4	4	4	4	3	3	2	2
I	0%		50%		100%		100%		100%		100%		100%	
II	0%		0%		0%		25%		50%		75%		100%	
III	0%		0%		0%		25%		50%		75%		100%	

SENNEBOGEN 643R

UDŹWIG MAKSYMALNY 40 TON

 **HERKULES**



30,0 m + 6,5 m



DIN
ISO



360°



7t + 4t

Tabela udźwignięw żurawia Sennebogen 643 R - wysięgnik podstawowy + wysięgnik pomocniczy 6,5m

m	długość [m]							
	9,0		16,0		23,0		30,0	
	0°	40°	0°	40°	0°	40°	0°	40°
2,0								
3,0	6,0		6,0					
4,0	6,0		6,0					
5,0	5,5	3,5	6,0		6,0			
6,0	4,9	3,3	6,0	3,6	6,0			
7,0	4,4	3,1	5,9	3,4	6,0		3,5	
8,0	4,0	2,9	5,4	3,3	5,9	3,4	3,5	
9,0	3,7	2,8	5,0	3,2	5,6	3,3	3,5	
10,0	3,4	2,7	4,6	3,1	5,3	3,2	3,5	3,2
11,0	3,1		4,3	3,0	5,0	3,2	3,5	3,0
12,0	2,8		4,1	2,8	4,7	3,1	3,5	2,9
13,0			3,9	2,8	4,2 / 4,4	3,0	3,5	2,8
14,0			3,7 / 3,3	2,8	3,7 / 4,2	2,9	3,3	2,7
15,0			3,4 / 3,5		3,3 / 3,9	2,9	3,0	2,5
16,0			3,0 / 3,3		3,0 / 3,7	2,8	2,8	2,4
18,0			2,3 / 2,9		2,4 / 3,3	2,7	2,3 / 2,4	2,3
20,0					1,9 / 2,7	2,1 / 2,6	1,8 / 2,1	2,1
22,0					1,5 / 2,2		1,5 / 1,9	1,7 / 1,9
24,0					1,1 / 1,7		1,1 / 1,8	1,4 / 1,7
26,0					0,8 / 1,4		0,9 / 1,5	1,0 / 1,6
28,0							0,7 / 1,2	
30,0							-0,9	
32,0							-0,7	
34,0								
36,0	Tab-Nr.: 643R-30.0/75/1977/5.4/08.06 SA6.5							
38,0	Tab-Nr.: 643R-30.0/75/1977/7.0/08.06 SA6.5							
parts reeving	2	I	2	2	2	I	I	I
I	0%		100%		100%		100%	
II	0%		0%		50%		100%	
III	0%		0%		50%		100%	



30,0 m + 13,0 m

Tabela udźwignięw żurawia Sennebogen 643 R - wysięgnik podstawowy + wysięgnik pomocniczy 13 m

m	długość [m]							
	9,0		16,0		23,0		30,0	
	0°	40°	0°	40°	0°	40°	0°	40°
2,0								
3,0	3,0							
4,0	3,0							
5,0	3,0		3,0					
6,0	3,0		3,0					
7,0	2,9		3,0		3,0			
8,0	2,6		3,0		3,0			
9,0	2,3		2,9		3,0		2,0	
10,0	2,1	1,6	2,7		2,9		2,0	
11,0	2,0	1,5	2,5		2,7		2,0	
12,0	1,8	1,4	2,4	1,5	2,6		2,0	
13,0	1,7	1,4	2,2	1,5	2,5		2,0	
14,0	1,6	1,3	2,1	1,5	2,4	1,5	2,0	
15,0	1,6	1,3	2,0	1,4	2,3	1,5	2,0	
16,0	1,5	1,3	1,9	1,4	2,2	1,4	2,0	1,5
18,0	1,1		1,7	1,3	2,0	1,4	2,0	1,4
20,0			1,6	1,3	1,8	1,3	1,9	1,4
22,0			1,4		1,7	1,3	1,7	1,3
24,0			1,3		1,6	1,3	1,4 / 1,6	1,3
26,0					1,3 / 1,4	1,3	1,2 / 1,4	1,2
28,0					1,0 / 1,3		1,0 / 1,3	1,2
30,0					0,8 / 1,3		0,8 / 1,2	1,1
32,0					0,6 / 1,1		0,6 / 1,1	0,8 / 1,1
34,0							- / 0,9	
36,0	Tab-Nr.: 643R-30.0/75/1977/5.4/08.06 SA13.0							
38,0	Tab-Nr.: 643R-30.0/75/1977/7.0/08.06 SA13.0							
parts reeving	I	I	I	I	I	I	I	I
I	0%		100%		100%		100%	
II	0%		0%		50%		100%	
III	0%		0%		50%		100%	



HERKULES

www.gzsa.pl

SENNEBOGEN 643R

UDŹWIG MAKSYMALNY 40 TON

 **HERKULES**

Zasięg pracy: wysięgnik podstawowy i pomocniczy

