

TEREX CBR 40H

MAXIMUM CAPACITY: 4 TONS

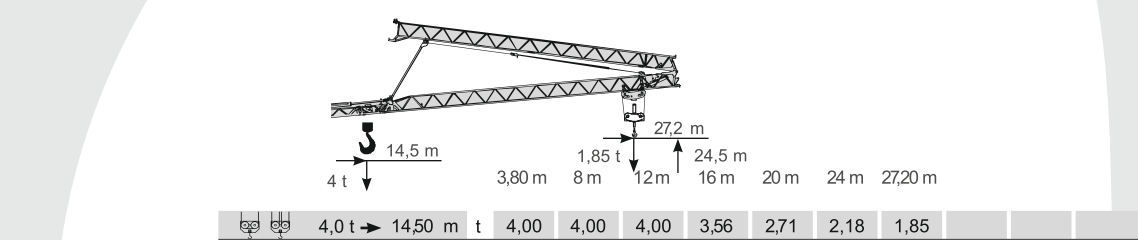

Load diagram

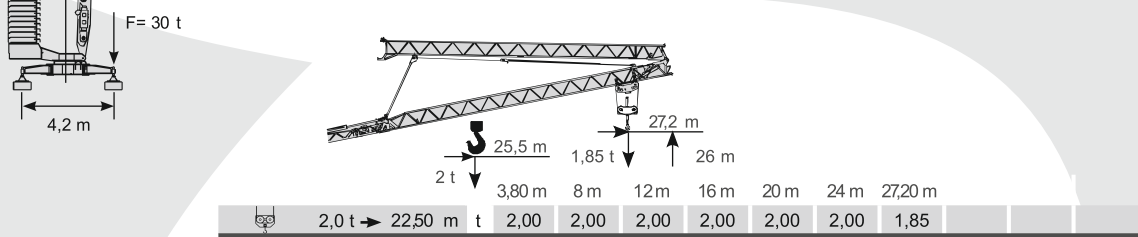
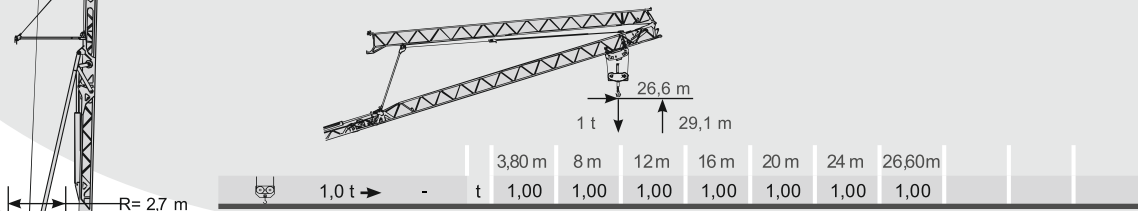
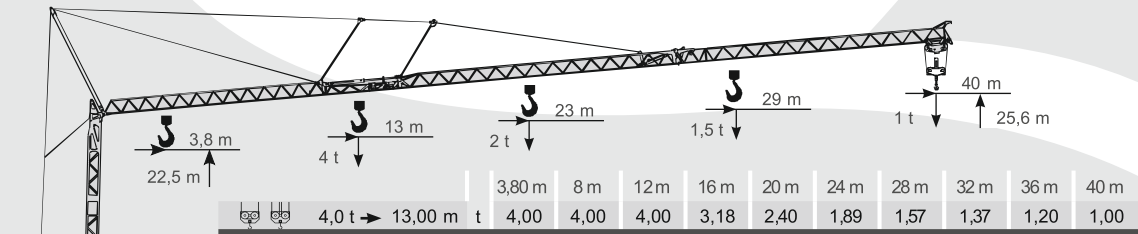
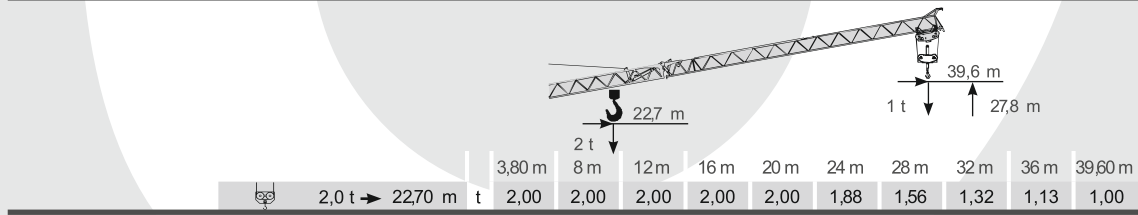
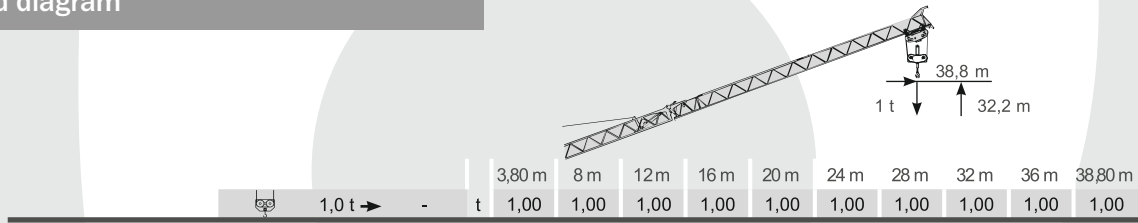

TECHNICAL DATA:

MAXIMUM LOAD: 4 TONS

MAIN BOOM: 40 m

TEREX CBR 40H

MAXIMUM CAPACITY: 4 TONS



Dimension

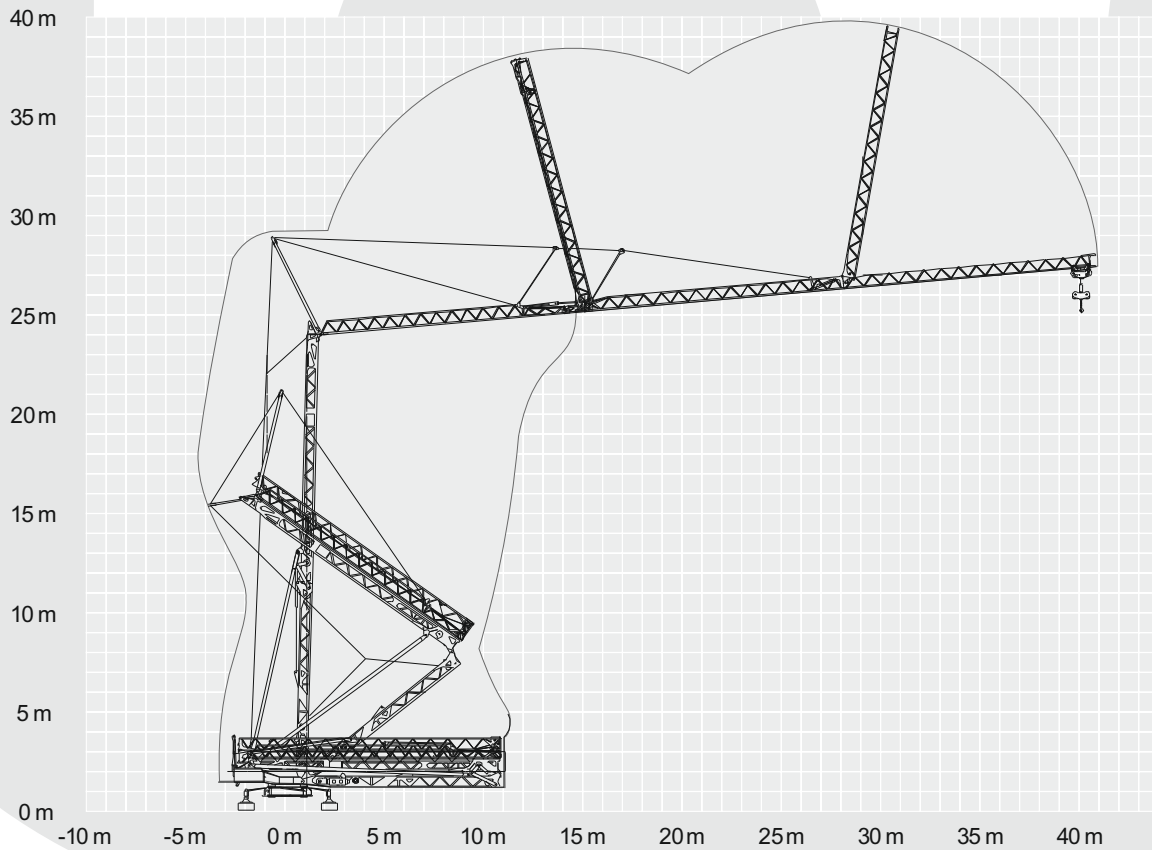

Transport

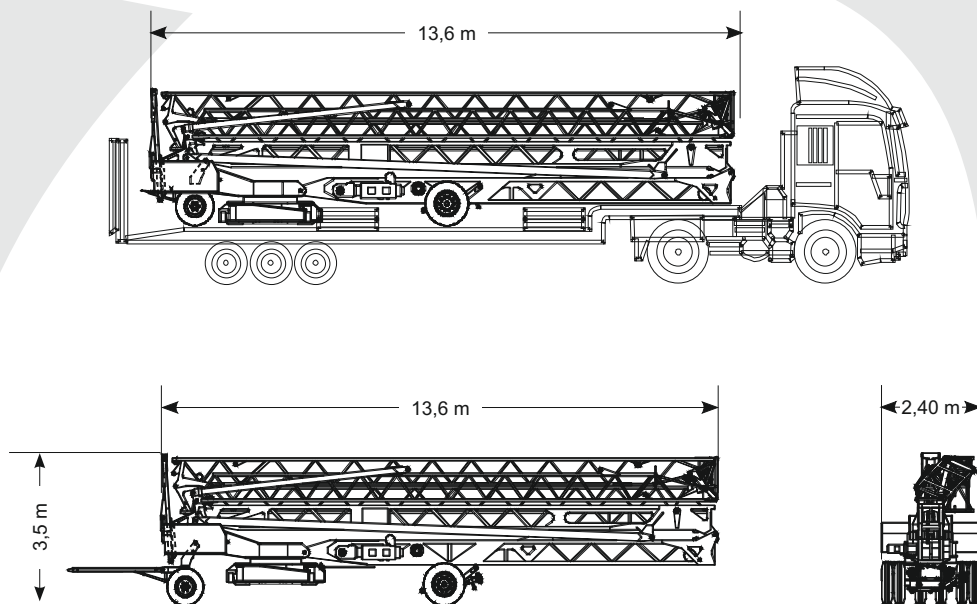





TEREX CBR 40H

MAXIMUM CAPACITY: 4 TONS



Mechanisms

							
		m/min	kg	kW	m/min	kg	kW
Hoisting		0 → 6	2000	8,8	0 → 3	4000	8,8
		6 → 23	2000		3 → 11,5	4000	
		23 → 46	1000		11,5 → 23	2000	
Trolleying		0 → 16 → 46		3	0 → 16 → 46		3
Slewing		0 → 0,2 → 0,8 obr / min					60 Nm
Erection							2,2
Power requirements							20 kVA
Main supply							400 V - 50 Hz
Completion ballast							25680 kg
Crane weight without ballast							15400 kg